

Professional
Camera Systems
for Integrators

vaddio
REDEFINING CAMERA CONTROL



Vaddio LIST Price Guide for North America - Effective July 1, 2009

Toll Free: 800-572-2011

vaddio.com













Vaddio Product Index





Vaddio Vaddio Vaddio	ProductionVIEW™ Switchers and Controllers ProductionVIEW Accessories ProductionVIEW Rack Consoles	3
Vaddio/Panasonic Vaddio/Sony Vaddio Vaddio	Vaddio/Panasonic Switcher Bundle Vaddio/Sony Switcher Bundle PreVIEW™ Monitor Series ProductionVIEW Control Triggers	4
Vaddio Vaddio Vaddio	TrackVIEW Systems and Programming Service TrackVIEW Triggers (AutoVIEW™ IR Sensor, StepVIEW Mats) ControlVIEW XHD, Xtreme and Peripherals (TouchVIEW™, MicVIEW™)	5
Vaddio Vaddio Vaddio Vaddio	Control Accessories (Microphone and Snake) AutoVIEW™ IR System and AutoVIEW IR Sensors StepVIEW™ Mats WallVIEW and Quick-Connect CCU Camera Systems	6
Vaddio Vaddio	WallVIEW and Quick-Connect CCU Camera Systems (continued) WallVIEW PRO Camera Systems	7
Vaddio Vaddio	WallVIEW PRO Camera Systems (continued) WallVIEW Camera Systems	8
Vaddio Vaddio Vaddio Vaddio	WallVIEW Camera Systems (continued) CeilingVIEW CCU Document Camera Systems CeilingVIEW Document Camera Systems and Rack Panel Accessory CeilingVIEW Camera Systems	9
Vaddio Sony Canon Vaddio	EZCamera PTZ Series BRC-300 Camera VC-C50i & 50iR PTZ Cameras PTZCAM 100	10
Vaddio Vaddio Vaddio Vaddio/Canon Panasonic Sony Sony	PTZCAM 70 IR Remote Commander ClearVIEW HD-18 PTZ Camera Vaddio/Canon BU-Series HD PTZ Camera Bundles AW-HE100 PTZ Camera BRC-H700 Camera BRC-Z700 Camera	11
Sony Vaddio Vaddio	BRC-Z330 and EVI-HD1 CoverVIEW IN-Wall Enclosures	12
Vaddio Vaddio Vaddio Vaddio	IN-Wall Enclosures (continued) Add-A-Cam™ Pro Base System Pan/Tilt PRO™ Mounting Accessories EZ Camera Cable Components	13
Vaddio Vaddio Vaddio	EZ Camera Cable Components (continued) Long Range System - EVI-D70 Camera and Codec Mounting Brackets	14
Vaddio Vaddio	Codec Mounting Brackets (continued) Ceiling Mounting Brackets and Accessories	15
Vaddio Vaddio Vaddio	Ceiling Mounting Brackets and Accessories (continued) Standard, Universal, Expandable Wall Mounts for PTZ Cameras DomeVIEW™ Series Camera Systems and Mounts	16
Vaddio	DomeVIEW™ Series Camera Systems and Mounts	17
Vaddio	DomeVIEW Accessories	18

Camera Control Systems





	Product	Model #	List Price
Operator Control Systems			
	ProductionVIEW HD-SDI HD/SD-SDI Camera Control System with Transitions and Effects <ul style="list-style-type: none"> • 6 HD/SD-SDI Inputs can be up-converted or down-converted from SD-SDI up to 3 Gig HD-SDI output resolutions • Transitions include Cross fade, wipes (9), cut, Fade to Black (FTB) • Same camera presets capability as other ProductionVIEW models • Lower Screen Graphics feature for inserting graphics over video • Knobs for adjusting Focus, Iris, Transition Speed as well as Pan, Tilt and Zoom built into the console, along with a new joystick 	999-5650-000	\$9,995.00
	UXHD CrossPoint Universal video format converter for two input sources <ul style="list-style-type: none"> • Converts 1 analog HD/SD/RGBHV video input to HD/SD-SDI output • Converts 1 HD/SD-SDI video input to analog HD/SD/RGBHV output 		Available Sept. 2009
	ProductionVIEW HD High Definition Camera Control System with Transitions and Effects <ul style="list-style-type: none"> • 6 HD/SD Inputs can be up/down-converted from 480i (SD) to 1080p (HD) and a variety of analog SD/HD or RGBHV output resolutions • Transitions include Cross fade, wipes (9), cut, Fade to Black (FTB) • Same camera preset capability as other ProductionVIEW models • Lower Screen Graphics feature for inserting graphics over video • Knobs for adjusting Focus, Iris, Transition Speed as well as Pan, Tilt and Zoom built into the console, along with a new joystick 	999-5600-000	\$9,995.00
	ProductionVIEW HD Component Cable - 7 in. • Use for HD YPbPr inputs or outputs on ProductionVIEW HD switcher DB-15 to 5 Female BNCs (for HD Component - YPbPr or RGBHV signals)	440-5600-003	\$45.00
	ProductionVIEW HD Component Cable - 6 ft. • Use for HD YPbPr inputs or outputs on ProductionVIEW HD switcher DB-15 to 5 Male BNCs (for HD Component - YPbPr or RGBHV signals)	440-5600-002	\$50.00
	ProductionVIEW HD Component Cable - 3 ft. • Use for HD YPbPr inputs or outputs on ProductionVIEW HD switcher DB-15 to 5 Male BNCs (for HD Component - YPbPr or RGBHV signals)	440-5600-001	\$50.00
	ProductionVIEW HD Y-C & Composite Cable - 1 ft. • Use for Y-C or Composite SD inputs or outputs on ProductionVIEW HD DB-15 to 3 Female BNCs (Y-C and Composite)	440-5600-000	\$50.00
	ProductionVIEW FX Camera Control System with Transitions and Effects <ul style="list-style-type: none"> • 3-axis joystick for up to six (6) PTZ cameras • Transitions include Fades (in, out, black) Cross fades, wipes (up, down, left, right, corner) - Transitions on Preview bus • 6x2 video switcher (Main and Preview) with built-in 4" LCD monitor • 72 total internal camera presets (6 x 12 each camera) 	999-5200-000	\$3,995.00
	ProductionVIEW Super Joystick Camera Controller with Built-in 4" Preview Monitor <ul style="list-style-type: none"> • Six (6) Discrete, Auto-sensing RS-232C Camera Control Ports • 72 Total Camera Presets & External Control (RS-232 & Tally) 	999-5300-000	\$1,995.00
	ProductionVIEW Rack Mount Ears • 6-RU Rack Mount fit ProductionVIEW HD, FX and Super Joystick	998-5000-001	\$99.00
	ProductionVIEW Precision Camera Controller Camera Controller with Built-in CCU Control <ul style="list-style-type: none"> • Red & Blue Gain, Detail, Iris and Gain Controls • New Hall-Effect Joystick and Manual Focus Controls • Seven (7) Discrete, Auto-sensing RS-232C Camera Control Ports • External Control Capability (RS-232 & Tally) 	999-5700-000	\$2,495.00
	Precision Camera Controller Rack Mount Ears • 4-RU Rack Mount ears fits Precision Camera Controller	998-5000-002	\$99.00
	ProductionVIEW DV Capture • Analog A/V to digital video converter and capture device • For PC and MACFireWire/1394 Enabled Platforms	999-5410-000	\$795.00
	ProductionVIEW Rack Enclosure* Upper/Lower Rack Bay, Slant Top Rack for ProductionVIEW <ul style="list-style-type: none"> • Dual rack bay design, 8RU upper bay, 5RU lower bay • Holes for mounting multiple Enclosures to each other *Mounted equipment and drawer not included	998-5000-200	\$769.00

	Product	Model #	List Price
	ProductionVIEW Rack Enclosure Drawer* • Locking slide out drawer • Mounting hardware for ProductionVIEW Series switchers & controllers <i>*Mounted equipment not included</i>	998-5000-210	\$219.00
	Precision Camera Controller Rack Enclosure Drawer* • Locking slide out drawer • Mounting hardware for Precision Camera Controller <i>*Mounted equipment not included</i>	998-5000-211	\$219.00
	ProductionVIEW Rack Console* Dual Rack Bay, Slant Top Rack for ProductionVIEW • Dual rack bay design, 8RU upper bay, 7RU lower bay <i>*Mounted equipment not included</i>	998-5000-100	\$569.00
Vaddio/Broadcast Switcher Bundles			
	Vaddio/Panasonic AV-HS400 Switcher Bundle Panasonic AV-HS400 Switcher with cabling to connect to Vaddio Precision Camera Controller AV-HS400 comes with 4 HD/SD-SDI inputs and outputs standard Built-in multi-viewer, keying and digital effects	999-1000-400	\$11,890.00
	AV-HS04M1 - SDI Input Board	998-1000-410	\$1,950.00
	AV-HS04M2 - HD/SD Analog Component Input Board	998-1000-420	\$1,790.00
	AV-HS04M3 - DVI Input Board	998-1000-430	\$1,990.00
	AV-HS04M4 - HD Analog Component Output Board	998-1000-440	\$1,150.00
	AV-HS04M5 - DVI/Component Output Board	998-1000-450	\$2,390.00
	AV-HS04M6 - Analog Composite Output Board	998-1000-460	\$1,990.00
	AV-HS04M7 - HD/SD-SDI Output Board	998-1000-470	\$2,190.00
	Vaddio/Sony BRS-200 Switcher Bundle Sony BRS-200 Switcher with cabling to connect to Vaddio Precision Camera Controller System comes with 4 SDI inputs/outputs and 1 DVI output standard Built-in multi-viewer, keying and digital effects	999-1000-200	\$9,995.00
	BRSA-20SD1 - HD/SD-SDI 4 Input Card (cannot mix HD & SD video -- one or the other)	998-1000-210	\$2,600.00
	BRSA-20SA1 - Composite and S-Video Input Card (one of each)	998-1000-220	\$2,000.00
	BRSA-20DD1 - DVI-I Input Card	998-1000-230	\$2,000.00
	BRSA-20DD2 - DVI-I Output Card	998-1000-240	\$2,000.00
PreVIEW™ Series LCD Rack Mount Monitors			
	PreVIEW HD Dual 7.0 LCD Rack Mount Monitors • VGA, Component (YPbPr), S-Video and Composite Video Inputs • Auto-terminating Outputs (except VGA) • 3-RU Enclosure with Tilt Mechanism	999-5510-012	\$2,699.00
	PreVIEW HD Triple 5.0 LCD Rack Mount Monitors • VGA, Component (YPbPr), S-Video and Composite Video Inputs • Auto-terminating Outputs (except VGA) • 3-RU Enclosure with Tilt Mechanism	999-5510-013	\$3,199.00
	PreVIEW Dual 6.4 LCD Rack Mount Monitors • Dual 6.4" (162.6mm) Active Matrix 960 x 234 LCD Monitors • 3-RU Enclosure with ± 25° Tilt Mechanism (50° total tilt) • Color, Contrast, Brightness and On/Off Controls per LCD • Two (2) Inputs with Active Looping Outputs on BNCs	999-5500-002	\$1,495.00
	PreVIEW Triple 5.6 LCD Rack Mount Monitors Triple 5.6" (142.2 mm) Active Matrix 480 x 234 LCD Monitors • 3-RU Enclosure with ± 25° Tilt Mechanism (50° total tilt) • Three (3) Inputs with Active Looping Outputs on BNCs	999-5500-003	\$1,395.00
	PreVIEW Quad 4 LCD Rack Mount Monitors Quad 4" (101.6mm) Active Matrix 480 x 234 LCD Monitors • 2-RU Enclosure with ± 25° Tilt Mechanism (50° total tilt) • Four (4) Inputs with Active Looping Outputs on BNCs	999-5500-004	\$1,295.00
ProductionVIEW Control Triggers			
	AutoVIEW IR Sensor IR Sensor, Interface controller, Cable and Power Supply	999-1701-100	\$699.00
	StepVIEW Mat – Small Exposed - 75' attached cable Presence-Sensing Auto Locator Mat - 44"(1.12m) x 27.5"(70cm)	999-1511-000	\$699.00
	StepVIEW Mat – Large Exposed - 75' attached cable Presence-Sensing Auto Locator Mat - 57"(1.45m) x 27.5"(70cm)	999-1512-000	\$699.00
	Vaddio/Sony Joystick Control Bundle VISCA PTZ Camera Controller • Custom 20' VISCA and 20' video switcher cables	999-6605-000	\$1,695.00





Product	Model #	List Price	
TrackVIEW Systems			
	TrackVIEW 70 System Camera Tracking System with Reference and Tracking Camera Tracking Camera Includes: • One (1) TrackVIEW Controller, IR remote, power supply, rack ears and system setup software • Two (2) Sony EVI-D70 PTZ Cameras: One (1) Sony EVI-D70 PTZ Camera with EZCamera Shoe and wide angle lens (reference camera) One (1) Sony EVI-D70 PTZ Camera with EZCamera Shoe and Vaddio IR Remote Commander (tracking camera) • One (1) Vaddio Dual Camera Mount for Dual Model 70	999-7000-070	\$7,695.00
	TrackVIEW 100 System Camera Tracking System for Smaller Rooms with Reference and Tracking Cameras Includes: • One (1) TrackVIEW Controller, IR remote, power supply, rack ears and system setup software • One (1) Sony EVI-D70 PTZ Camera with EZCamera Shoe and wide angle lens (reference camera) • One (1) Sony EVI-D100 PTZ Camera with EZCamera Shoe (10X optical zoom) and Vaddio IR Remote Commander (tracking camera) • One (1) Dual Camera Mount for Dual Model 70/100	999-7000-100	\$7,495.00
	TrackVIEW HD1 System Camera Tracking System with Reference and High Definition Tracking Camera Includes: • One (1) TrackVIEW Controller, IR remote, power supply, rack ears and system setup software • One (1) Sony EVI-D70 PTZ Camera with EZCamera Shoe and wide angle lens (reference camera) • One (1) Sony EVI-HD1 Camera with the EZCamera Shoe HD1, Quick-Connect HD1, 36 VDC power supply (tracking camera) • One (1) Dual Camera Mount for Dual Models 70 and HD1	999-7000-630	\$11,995.00
	TrackVIEW System Programming Single day on-site programming of TrackVIEW system by Vaddio technical staff. System must be installed, ready for programming. NOTE: * Travel expenses additional.	999-PROG-000	\$1,500.00 *
Automated Control Systems - TrackVIEW Preset Triggers			
	AutoVIEW IR Sensor Single ceiling-mounted active IR sensor kit for TrackVIEW • Active IR sensor and acrylic lens cover	999-1711-100	\$699.00
	StepVIEW Mat – Small Exposed Presence-Sensing Auto Locator Mat - 44"(1.12m) x 27.5"(70cm) • Attached 75'(22.9m) cable	999-1511-000	\$699.00
	StepVIEW Mat – Large Exposed Presence-Sensing Auto Locator Mat - 57"(1.45m) x 27.5"(70cm) • Attached 75'(22.9m) cable	999-1512-000	\$699.00
ControlVIEW XHD, ControlVIEW Xtreme and Peripherals			
	ControlVIEW™ XHD Pan/Tilt/Zoom Camera Control System with IR Remote Control • Controls up to Six (6) PTZ Cameras w/auto camera detection • Seamless switching, with cross-fade, wipe or cut transition • Up to 72 camera presets • Compatible with StepVIEW, AutoVIEW IR, MicVIEW & TouchVIEW	999-5672-000	\$5,495.00
	ControlVIEW XHD Component Cable - 7 in. • Use for HD YPbPr inputs or outputs on ProductionVIEW HD switcher DB-15 to 5 Female BNCs (for HD Component - YPbPr or RGBHV signals)	440-5600-003	\$45.00
	ControlVIEW XHD Component Cable - 6 ft. • Use for HD YPbPr inputs or outputs on ProductionVIEW HD switcher DB-15 to 5 Male BNCs (for HD Component - YPbPr or RGBHV signals)	440-5600-002	\$50.00
	ControlVIEW XHD Component Cable - 3 ft. • Use for HD YPbPr inputs or outputs on ProductionVIEW HD switcher DB-15 to 5 Male BNCs (for HD Component - YPbPr or RGBHV signals)	440-5600-001	\$50.00
	ControlVIEW XHD Y-C & Composite Cable - 1 ft. • Use for Y-C or Composite SD inputs or outputs on ProductionVIEW HD DB-15 to 3 Female BNCs (Y-C and Composite)	440-5600-000	\$50.00

	Product	Model #	List Price
	ControlVIEW™ Xtreme Pan/Tilt/Zoom Camera Control System with IR Remote Control • Controls up to Four (4) VISCA PTZ Cameras • Up to 72 camera presets • Release 1.65 supports Polycom and TANDBERG codecs via RS-232	999-1072-000	\$2,995.00
	TouchVIEW Wireless Remote Control System for ControlVIEW XHD & Xtreme, ProductionVIEW and TrackVIEW Four (4) RF remote buttons and one (1) TouchVIEW Receiver • Up to fifteen systems can be added to ControlVIEW XHD / Xtreme	999-1201-000	\$795.00
	MicVIEW - Teleconference Mic Switcher/Mixer • 12 Mic Inputs, 12 Trigger/Logic outputs • Link up to eight (8) mixers for 96 channels • Phantom Power for Electret Condenser Mics • Designed for use with 3-wire mic, PN 701-0001-891	999-0001-000	\$1,695.00
	6-Channel Microphone Extension Snake 25' (7.6m) Mic Extension Snake for MicVIEW • Six (6) XLR-F snake box to six shielded pair wires	999-3000-006	\$399.00
	Unidirectional Boundary Microphone Audio-Technica® Boundary Microphone for MicVIEW • Assignable switch for operation (touch on/off/mom) 25'(7.6m) cable • 25'(7.6m) detachable cable; TA3F to XLR-M type	701-0001-891	\$299.00













Automated Control Systems

	AutoVIEW IR System Presenter's Camera Control System for ControlVIEW Xtreme Only • AutoVIEW Control Expander with PowerRite Power Supply supports up to eight (8) triggers • Three (3) IR sensors with interface controllers and power supplies	999-1700-000	\$2,699.00
	AutoVIEW IR Sensor Single IR Ceiling-Mounted Presenter Sensor • AutoVIEW IR Interface Controller & PowerRite Power Supply	999-1701-100	\$699.00
	StepVIEW with Exposed Mats Presenter's Camera Location System for ControlVIEW Xtreme Only • AutoVIEW Control Expander with PowerRite Power Supply supports up to eight (8) triggers • Two (2) Small and One (1) Large Exposed AutoLocator Mats	999-1500-000	\$2,699.00
	StepVIEW Mat - Small Exposed Presence-Sensing Auto Locator Mat - 44"(1.12m) x 27.5"(70cm) • Attached 75'(22.9m) cable & StepVIEW Interface	999-1501-000	\$699.00
	StepVIEW Mat - Large Exposed Presence-Sensing Auto Locator Mat - 57"(1.45m) x 27.5"(70cm) • Attached 75'(22.9m) cable & StepVIEW Interface	999-1502-000	\$699.00

Professional Camera Series

	WallVIEW CCU HD-18 High Definition Pan/Tilt/Zoom Camera Control Unit System includes: • ClearVIEW HD-18 High Definition Camera and remote • 18x Lens; 1080p, 1080i or 720p HD with simultaneous SD output • Red & Blue Gain, Detail, Chroma, Gamma, Pedestal, Iris & Gain • Video, power & control over Cat. 5 cabling up to 500' • EZIM CCU Card for camera, wall mount bracket and Power Supply	999-6907-000	\$5,495.00
	WallVIEW CCU HE100 High Definition Pan/Tilt/Zoom Camera Control Unit System includes: • 12 Volt DC Panasonic AW-HE100 High Definition Camera and remote • 13x Lens 720p/1080i (switchable) with simultaneous SD output • Red & Blue Gain, Detail, Chroma, Gamma, Pedestal, Iris & Gain • Video, power & control over Cat. 5 cabling up to 500' • Heavy-duty wall mount bracket and Power Supply	999-6107-000	\$10,795.00
AW-HHD - HD-SDI Interface Card for WallVIEW HE100 PTZ		999-6100-010	\$1,995.00
	WallVIEW CCU H700 High Definition Pan/Tilt/Zoom Camera Control Unit System includes: • Sony BRC-H700 High Definition Camera (12x Lens/1080i) and remote • Red & Blue Gain, Detail, Color & Hue Gain, WB Shift, Iris & Gain • Video, power & control over Cat. 5 cabling up to 500' • Heavy-duty wall mount bracket and Power Supply	999-6707-000	\$11,195.00
	Quick-Connect CCU for BRC-H700 • Kit includes all items in the WallVIEW system except BRC-H700 Camera	998-6707-000	\$2,995.00
HFBK-HD1 - HD-SDI Interface Card for WallVIEW 700 PTZ		999-6700-010	\$2,000.00
HFBK-SD1 - SD-SDI, Analog RGB/Component/S-video/Composite Interface Card for WallVIEW 700 PTZ		999-6700-020	\$1,700.00
HFBK-XG1 - XGA Output Board (VGA, XGA, WXGA Option)		999-6700-030	\$2,000.00



Product		Model #	List Price
	WallVIEW CCU Z700 High Definition Pan/Tilt/Zoom Camera Control Unit System includes: • Sony BRC-Z700 High Definition Camera (20x Lens/1080i) and remote • Red & Blue Gain, Detail, Red, Green, Blue Enhance, Iris & Gain • Video, power & control over Cat. 5 cabling up to 500' • Simultaneous SD and HD outputs • Heavy-duty wall mount bracket and Power Supply	999-6807-000	\$10,595.00
	Quick-Connect CCU for BRC-Z700 • Kit includes all items in the WallVIEW system except BRC-Z700 Camera	998-6807-000	\$2,995.00
BRBK-HSD1 -- HD/SD-SDI Output Card		999-6800-010	\$1,800.00
	WallVIEW CCU Z330 High Definition Pan/Tilt/Zoom Camera Control Unit System includes: • Sony BRC-Z330 High Definition Camera (1080i or 720p - switchable) • Red & Blue Gain, Detail, Red, Green & Blue Enhance, Iris & Gain • Video, power & control over Cat. 5 cabling up to 500' • Thin profile wall mount bracket and Power Supply	999-6857-000	Call for Pricing
BRBK-HD2 -- HD-SDI Output Card for BRC-Z330			Call for Pricing
	Quick-Connect CCU for BRC-Z330 • Kit includes all items in the WallVIEW system except BRC-Z330		Call for Pricing
	WallVIEW CCU 300 Standard Definition Pan/Tilt/Zoom Camera Control Unit System includes: • Sony BRC-300 with 3 CCD module and 12x Lens and remote • Red & Blue Gain, Aperture, Iris & Gain Adjustments • Video, power & control over Cat. 5 cabling up to 500' • Thin profile wall mount bracket and Power Supply • Simultaneous Y-C (S-video) and Composite outputs	999-6207-000	\$5,995.00
	Quick-Connect CCU for BRC-300 • Kit includes all items in the WallVIEW system except BRC-300 Camera	998-6207-000	\$2,795.00
BRBK-301, Analog/RGB Component Card for WallVIEW 300 PTZ		999-6600-000	\$499.00
BRBK-302, SDI Card for WallVIEW 300 PTZ		999-6601-000	\$975.00
BRBK-303, Optical Multiplex Card for WallVIEW 300 PTZ		999-6602-000	\$895.00
BRBK-304, DV I.Link Interface Card (Fire Wire)		999-6606-000	\$975.00
BRU-300, Optical Multiplex Unit for WallVIEW 300 PTZ		999-6603-000	\$2,100.00
CCFC-M100, Optical Fiber Card for WallVIEW 300 PTZ		999-6604-000	\$799.00
	WallVIEW CCU HD1 High Definition Pan/Tilt/Zoom Camera Control Unit System includes: • Sony EVI-HD1 High Definition Camera (1080i, 720p, 480i) • Red & Blue Gain, Aperture, Iris & Gain Adjustments • Video, power & control over Cat. 5 cabling up to 500' • Thin profile wall mount bracket and Power Supply	999-6307-000	\$6,295.00
Optional WallVIEW CCU SD Break Out Cable for HD1		440-6207-000	\$85.00
	Quick-Connect CCU for EVI-HD1 • Kit includes all items in the WallVIEW system except EVI-HD1 Camera	998-6307-000	\$2,795.00
	WallVIEW HD-18 High Definition Pan/Tilt/Zoom Camera System includes: • ClearVIEW HD-18 High Definition Camera and remote • 18x Lens; 1080p, 1080i or 720p HD with simultaneous SD output • EZCamera Cabling System with Quick-Connect SR for running video & power over a single Cat. 5 cable up to 100' using camera EZ-Port • Easy integration with a variety of videoconference codecs	999-6905-000	\$4,795.00
	Rack Panel* for WallVIEW HD-18 Quick-Connect SR • Holds up to three (3) WallVIEW Quick-Connect SR Boxes on 1RU *Quick-Connect SR Box not included	998-6000-002	\$70.00
	WallVIEW PRO HE100 High Definition Pan/Tilt/Zoom Camera System includes: • 12 Volt DC Panasonic AW-HE100 High Definition Camera and remote • 13x Lens 720p/1080i (switchable) • Pro Series EZCamera Cabling System for running video, power, IR & control over Cat. 5 cabling up to 500' • Heavy-duty wall mount bracket and Power Supply	999-6105-000	\$9,995.00
AW-HHD - HD-SDI Interface Card for WallVIEW HE100 PTZ		999-6100-010	\$1,995.00
	WallVIEW PRO H700 High Definition Pan/Tilt/Zoom Camera System includes: • Sony BRC-H700 High Definition Camera (12x Lens/1080i) and remote • Pro Series EZCamera Cabling System for running video, power, IR & control over Cat. 5 cabling up to 500' • Heavy-duty wall mount bracket and Power Supply	999-6704-000	\$9,995.00
HFBK-HD1 - HD-SDI Interface Card for WallVIEW 700 PTZ		999-6700-010	\$2,000.00
HFBK-SD1 - SD-SDI, Analog RGB/Component/S-video/Composite Interface Card for WallVIEW 700 PTZ		999-6700-020	\$1,700.00
HFBK-XG1 - XGA Output Board (VGA, XGA, WXGA Option)		999-6700-030	\$2,000.00

Product		Model #	List Price
	WallVIEW PRO Z700 High Definition Pan/Tilt/Zoom Camera System includes: • Sony BRC-Z700 High Definition Camera (20x Lens/1080i) and remote • Pro Series EZCamera Cabling System for running IR, video, power & control over Cat. 5 cabling up to 500' • Simultaneous SD and HD outputs • Heavy-duty wall mount bracket and Power Supply	999-6805-000	\$9,595.00
BRBK-HSD1 -- HD/SD-SDI Output Card		999-6800-010	\$1,800.00
	WallVIEW PRO Z330 High Definition Pan/Tilt/Zoom Camera System includes: • Sony BRC-Z330 High Definition Camera (1080i or 720p - switchable) • Pro Series EZCamera Cabling System for running IR, video, power & control over Cat. 5 cabling up to 500' • Thin profile wall mount bracket and Power Supply	999-6855-000	Call for Pricing
BRBK-HD2 -- HD-SDI Card for BRC-Z330			Call for Pricing
	WallVIEW PRO 300 Standard Definition Pan/Tilt/Zoom Camera System includes: • Sony BRC-300 with 3 CCD module and 12x Lens and remote • Pro Series EZCamera Cabling System for running IR, video, power & control over Cat. 5 cabling up to 500' • Thin profile wall mount bracket and Power Supply	999-6205-000	\$5,495.00
BRBK-301, Analog/RGB Component Card for WallVIEW 300 PTZ		999-6600-000	\$499.00
BRBK-302, SDI Card for WallVIEW 300 PTZ		999-6601-000	\$975.00
BRBK-303, Optical Multiplex Card for WallVIEW 300 PTZ		999-6602-000	\$895.00
BRBK-304, DV I.Link Interface Card (Fire Wire)		999-6606-000	\$975.00
BRU-300, Optical Multiplex Unit for WallVIEW 300 PTZ		999-6603-000	\$2,100.00
CCFC-M100, Optical Fiber Card for WallVIEW 300 PTZ		999-6604-000	\$799.00
	WallVIEW PRO HD1 High Definition Pan/Tilt/Zoom Camera System includes: • Sony EVI-HD1 High Definition Camera (1080i, 720p, 480i) • Pro Series EZCamera Cabling System for running IR, video, power & control over Cat. 5 cabling up to 500' • Thin profile wall mount bracket and Power Supply	999-6305-000	\$5,695.00
Optional WallVIEW PRO SD Break Out Cable for HD1		440-6204-000	\$85.00
	WallVIEW PRO EagleEye 1080 HD High Definition System includes: • Pro Series EZCamera Cabling System for running IR, video, power & control over Cat. 5 cabling up to 500' • Thin profile wall mount bracket and Power Supply • Polycom IR pass-thru	999-9510-000	\$1,595.00
*camera not included			
	WallVIEW PRO EagleEye High Definition System includes: • Pro Series EZCamera Cabling System for running IR, video, power & control over Cat. 5 cabling up to 500' • Thin profile wall mount bracket and Power Supply • Polycom IR pass-thru	999-9500-000	\$1,595.00
*camera not included			
WallVIEW Camera Systems			
	WallVIEW 100 PTZ Pan/Tilt/Zoom Camera System includes: • Sony EVI-D100 PTZ Camera (Platinum Gray) • EZCamera Cable System for video, power and control over Cat. 5 • Thin profile wall mount bracket and Power Supply	999-2204-000	\$1,549.00
	WallVIEW 100 PTZ - Black Camera Version - NTSC Pan/Tilt/Zoom Camera System - Same as above in Black	999-2204-000B	\$1,699.00
	WallVIEW 70 PTZ Pan/Tilt/Zoom Camera System includes: • Sony EVI-D70 PTZ Camera (Platinum White) • EZCamera Cable System for video, power and control over Cat. 5 • Thin profile wall mount bracket and Power Supply	999-2704-000	\$1,749.00
	WallVIEW 70 PTZ - Black Camera Version - NTSC Pan/Tilt/Zoom Camera System - Same as above in Black	999-2704-000B	\$1,929.00
	WallVIEW 50i PTZ Pan/Tilt/Zoom Camera System includes: • Includes a Canon VC-C50i PTZ Camera • EZCamera Cable System for video, power and control over Cat. 5 • Thin profile wall mount bracket and Power Supply	999-4204-000	\$1,649.00

	Product	Model #	List Price
	WallVIEW 50i PTZ HideAway Installed PTZ Wall Camera with Motorized In-Wall Camera Lift System Includes a Canon VC-C50i PTZ Camera <ul style="list-style-type: none"> • When closed, the camera is concealed. When activated, the door opens to reveal the camera. • EZCamera Cable System for video, power and control over Cat. 5 • VISCA control interface 	999-4404-000	\$2,995.00
	CeilingVIEW HD CCU Same as CeilingVIEW HD with the addition of CCU to adjust: <ul style="list-style-type: none"> • Red & Blue Gain • Aperture (provides detail to written words) • Iris • Gain 	999-3009-000	\$5,995.00
	CeilingVIEW SD CCU Same as CeilingVIEW SD with the addition of CCU to adjust: <ul style="list-style-type: none"> • Red & Blue Gain • Aperture (provides detail to written words) • Iris • Gain 	999-2009-000	\$3,295.00
	CeilingVIEW HD High Definition 720p/1080i Ceiling-Mounted Document Camera <ul style="list-style-type: none"> • Selectable Output Resolutions 480i, 720p and 1080i with 10X zoom • Selectable aspect ratio -- 4:3 or 16:9 • Laser light locator for document positioning • IR remote control • Compatible with Vaddio, Polycom and TANDBERG remote controls • Plenum rated enclosure with ceiling tile supports • Pro Series EZCamera Cabling System for running video, power & control over Cat. 5 cabling up to 400' • Mounting hardware and PowerRite Power Supply 	999-3008-000	\$4,995.00
Product		Model #	List Price
	CeilingVIEW SD Ceiling-Mounted Standard Definition Document Camera <ul style="list-style-type: none"> • High-resolution camera with 36X zoom • Laser light locator for document positioning • IR remote control • Plenum rated enclosure with ceiling tile supports • Pro Series EZCamera Cabling System for running video, power & control over Cat. 5 cabling up to 400' • Mounting hardware and PowerRite Power Supply 	999-2008-000	\$2,295.00
	Rack Panel* for CeilingVIEW HD/SD <ul style="list-style-type: none"> • Holds up to three (3) CeilingVIEW Quick-Connect Boxes *Quick-Connect Box not included	998-6000-002	\$70.00
Ceiling Camera Systems			
	CeilingVIEW 50iR PTZ Ceiling-Mounted Pan/Tilt/Zoom Camera System <ul style="list-style-type: none"> • Includes a Canon VC-C50iR PTZ Camera • Suspended ceiling PTZ camera mount • EZCamera Cabling System for Cat. 5 cabling to run power, video and camera control • PowerRite Power Supply included 	999-4304-000	\$1,649.00
	CeilingVIEW 70 PTZ Ceiling-Mounted Pan/Tilt/Zoom Camera System <ul style="list-style-type: none"> • Includes a Sony EVI-D70 PTZ Camera • Concealed ceiling camera enclosure with trim ring • EZCamera Cabling System for Cat. 5 cabling to run power, video and camera control • PowerRite Power Supply included 	999-2304-000	\$2,295.00
	CeilingVIEW 70 PTZ HideAway Installed PTZ Ceiling Camera with Motorized Camera Lift System <ul style="list-style-type: none"> • Includes a Sony EVI-D70 PTZ Camera • When the HideAway Camera Enclosure is off, the camera is retracted. When activated, the camera lowers into operating position. • EZCamera Cat. 5 Cabling System for power, video and camera control • PowerRite Power Supply included 	999-2404-000	\$2,995.00

	Product	Model #	List Price
EZCamera PTZ Series			
	Vaddio's Model 100 PTZ Camera Kit* PTZ Camera with Vaddio's EZCamera Cable Shoe <ul style="list-style-type: none"> • Featuring the Sony EVI-D100C/S PTZ Camera • 10X optical and 4X digital zoom lens • Vaddio's IR Remote Commander • Vaddio's EZCamera Cable Shoe System • Platinum Gray color blends well in all environments *NOTE: requires Cat. 5 cabling, quick-connect box, and Vaddio's PowerRite Power Supply; or Vaddio's Quick-Connect 4 Video, Power and Control Wiring Center	999-2001-100	\$1,295.00
	Vaddio's Model 70 PTZ Camera Kit* PTZ Camera with Vaddio's EZCamera Cable Shoe <ul style="list-style-type: none"> • Featuring the Sony EVI-D70C/W PTZ Camera • 18X optical and 12X digital zoom lens • Vaddio's IR Remote Commander • Vaddio's EZCamera Cable Shoe System • New Platinum White color blends well in all environments *NOTE: requires Cat. 5 cabling, quick-connect box, and Vaddio's PowerRite Power Supply; or Vaddio's Quick-Connect 4	999-2001-070	\$1,345.00
	Vaddio's Model 50i PTZ Camera Kit* PTZ Camera with Vaddio's EZCamera Cable Shoe <ul style="list-style-type: none"> • Featuring a Canon VC-C50i PTZ Camera • 26X optical and 12X digital zoom lens • Canon IR Remote Control • Vaddio's EZCable Camera Shoe System *NOTE: requires Cat. 5 cabling, quick-connect box, and Vaddio's PowerRite Power Supply; or Vaddio's Quick-Connect 4	999-2001-050	\$1,345.00
	Vaddio's Model 50iR PTZ Camera Kit* Ceiling-Mountable PTZ Camera with Vaddio's EZCamera Cable Shoe <ul style="list-style-type: none"> • Featuring a Canon VC-C50iR PTZ Camera • 26X optical and 12X digital zoom lens • Canon IR Remote Control • Vaddio's EZCable Camera Shoe System *NOTE: requires Cat. 5 cabling, quick-connect box, and Vaddio's PowerRite Power Supply; or Vaddio's Quick-Connect 4	999-2001-060	\$1,345.00
SD PTZ Cameras			
	Sony BRC-300 PTZ Camera Pan/Tilt/Zoom Camera System <ul style="list-style-type: none"> • Complete with remote control and power supply • 3CCD image sensors • 12X optical zoom, 4X digital (48X total zoom) • 4:3 or 16:9 selectable aspect ratio 	999-6000-000	\$4,899.00
	BRBK-301, Analog/RGB Component Card for WallVIEW 300 PTZ	999-6600-000	\$499.00
	BRBK-302, SDI Card for WallVIEW 300 PTZ	999-6601-000	\$975.00
	BRBK-303, Optical Multiplex Card for WallVIEW 300 PTZ	999-6602-000	\$895.00
	BRBK-304, DV i.Link Interface Card (Fire Wire)	999-6606-000	\$975.00
	BRU-300, Optical Multiplex Unit for WallVIEW 300 PTZ	999-6603-000	\$2,100.00
	CCFC-M100, Optical Fiber Card for WallVIEW 300 PTZ	999-6604-000	\$799.00
	Canon VC-C50i PTZ Camera Pan/Tilt/Zoom Camera System <ul style="list-style-type: none"> • Canon VC-C50i PTZ Camera • IR remote control • Power supply with power cable 	999-4000-000	\$1,295.00
	Canon VC-C50iR PTZ Camera Pan/Tilt/Zoom Camera System <ul style="list-style-type: none"> • Canon VC-C50iR PTZ Camera • Inverted for ceiling-mount applications • Ceiling-mount plate for a clean installation • IR remote control • Power supply with power cable 	999-4001-000	\$1,295.00
	Vaddio PTZCAM™ 100 Pan/Tilt/Zoom Camera System <ul style="list-style-type: none"> • Sony's EVI-D100C/S PTZ Camera • Platinum Gray color for a look that blends well in all environments • Vaddio IR Remote Commander • Power supply with power cable 	999-2100-100	\$1,195.00
	Sony EVI-D100 - Black <ul style="list-style-type: none"> • Sony EVI-D100, 12 VDC Power Supply and Remote 	999-2000-100	\$1,195.00

Product		Model #	List Price
	Vaddio PTZCAM 70 Pan/Tilt/Zoom Camera System • Sony's EVI-D70C/W PTZ Camera • Platinum White color for a look that blends well in all environments • Vaddio IR Remote Commander • Power supply with power cable	999-2100-070	\$1,295.00
	Sony EVI-D70 - Black • Sony EVI-D70, 12 VDC Power Supply and Remote	999-2000-070	\$1,295.00
	IR Remote Commander Compatible Remote Control for the following cameras • Vaddio/Sony based camera packages: • WallVIEW HD-18, 70, 100, 300, HD1, Z700 & H700 • CeilingVIEW 70 PTZ and 70 PTZ HideAway • EZCamera Series: Models 100 PTZ and Model 70 PTZ • PTZ Camera Packages: PTZCAM 100 and PTZCAM 70 • Controls the Vaddio HD-18, Sony EVI and BRC Series Cameras *NOTE: The IR Remote Commander replaces the std. Sony Remote	998-2100-000	\$99.00
HD PTZ Cameras			
	Vaddio ClearVIEW HD-18 High Definition PTZ Camera HD Pan/Tilt/Zoom Camera System • Simultaneous HD (1080p, 1080i or 720p) and SD outputs • Complete with remote control and AC cord • 1/3" 1.3 megapixel CCD Image Sensor • 18x optical zoom • Precision, high-torque micro-stepper motors	999-6900-000	\$3,995.00
	Vaddio/Canon BU-45H Outdoor HD PTZ Camera HD Pan/Tilt/Zoom Camera System • 12 Volt DC Powered Camera • Works with Precision Camera Controller & ProductionVIEW HD-SDI • Three 1/3" CCD Image Sensors • 1080i HD-SDI with simultaneous SD composite output • 20x optical zoom • Adapters for interoperation with Precision Camera Controller	999-4100-000	\$23,000.00
	Vaddio/Canon BU-50H Indoor HD PTZ Camera HD Pan/Tilt/Zoom Camera System • 120 Volt AC Powered Camera • Works with Precision Camera Controller & ProductionVIEW HD-SDI • Three 1/3" CCD Image Sensors • 1080i HD-SDI with simultaneous SD composite output • 20x optical zoom • Adapters for interoperation with Precision Camera Controller	999-4150-000	\$19,000.00
	Panasonic AW-HE100 High Definition PTZ Camera HD Pan/Tilt/Zoom Camera System • Standard 120 Volt AC Powered Camera • Complete with remote control and AC cord • Three 1/3" CCD Image Sensors • 1080i/720p (switchable) with simultaneous SD output • 13x optical zoom	999-6100-000	\$8,790.00
AW-HHD - HD-SDI Interface Card for WallVIEW HE100 PTZ		999-6100-010	\$1,995.00
	Sony BRC-H700 High Definition PTZ Camera HD Pan/Tilt/Zoom Camera System • Complete with remote control and power supply • Three 1/3-type IT CCD Image Sensors • Approximately 1.07 Megapixels per Sensor • 1080/59.94i,1080/50i (switchable) • 12x optical zoom,48x with digital zoom	999-6700-000	\$8,995.00
HFBK-HD1 - HD-SDI Interface Card for WallVIEW 700 PTZ		999-6700-010	\$2,000.00
HFBK-SD1 - SD-SDI, Analog RGB/Component/S-video/Composite Interface Card for WallVIEW 700 PTZ		999-6700-020	\$1,700.00
HFBK-XG1 - XGA Output Board (VGA, XGA, WXGA Option)		999-6700-030	\$2,000.00
	Sony BRC-Z700 High Definition PTZ Camera HD Pan/Tilt/Zoom Camera System • Simultaneous SD and HD outputs • Three 1/4-type CMOS Image Sensors • 1080/59.94i,1080/50i (switchable) • 20x optical zoom lens • Complete with remote control and power supply	999-6800-000	\$7,995.00
BRBK-HSD1 -- HD/SD-SDI Output Card		999-6800-010	\$1,800.00

Product		Model #	List Price
	Sony BRC-Z330 High Definition PTZ Camera HD Pan/Tilt/Zoom Camera System <ul style="list-style-type: none"> • Simultaneous SD and HD outputs • 1/3-type CMOS Image Sensor • 1080 or 720p Output (switchable) • 18x optical zoom lens • Complete with remote control and power supply 	999-6850-000	\$5,100.00
BRBK-HD2 -- HD-SDI Output Card		998-6850-010	\$1,400.00
	Sony EVI-HD1 High Definition Camera High Definition Pan/Tilt/Zoom Camera System 1/3-Type CMOS 2-Megapixel Image Sensor <ul style="list-style-type: none"> • 1080i, 720p, 480i Resolutions • IR remote control • Power supply with power cable 	999-6300-000	\$4,000.00





Camera Enclosures



CoverVIEW

	CoverVIEW Contemporary In-Wall Camera Cover Fits the following camera Systems: <ul style="list-style-type: none"> • Sony EVI-D100 • Vaddio WallVIEW 100 PTZ and Model 100 PTZ • Canon VC-C50i • Vaddio WallVIEW 50i PTZ and Model 50i PTZ <ul style="list-style-type: none"> • Plenum rated metal backbox with conduit knockouts • Back Box interior is black to eliminate reflection • Attractive ABS plastic cover • Clear Acrylic Lens (rigid and pre-installed) • Two trim clips that conceal the four mounting screws 		
	CoverVIEW for Canon VC-C50i - Black	999-2224-000	\$349.00
	CoverVIEW for Sony EVI-D100 - Black	999-2221-000	\$349.00
	CoverVIEW for Sony EVI-D100C/S White	999-2221-001	\$349.00

camera not included

IN-Wall Enclosures

	IN-Wall Enclosure for Model 50i and Model 100 Recessed Camera Mounting Enclosure for the following cameras: <ul style="list-style-type: none"> • Sony EVI-D100 PTZ Camera • Vaddio WallVIEW 100 PTZ • Vaddio Model 100 PTZ • Canon VC-C50i PTZ Camera • Vaddio WallVIEW 50i PTZ (w/o wall mount) • Vaddio Model 50i PTZ <ul style="list-style-type: none"> • Includes metal back box enclosure and face frame 	999-2225-001	\$199.00
camera not included			
	IN-Wall 70 Enclosure Recessed Camera Mounting Enclosure for the following cameras: <ul style="list-style-type: none"> • Sony EVI-D70 PTZ Camera • Vaddio WallVIEW 70 PTZ (w/o wall mount) • Vaddio Model 70 PTZ <ul style="list-style-type: none"> • Includes metal back box enclosure and face frame 	999-2225-012	\$199.00
camera not included			
	IN-Wall 300 Enclosure Recessed Camera Mounting Enclosure for the following cameras: <ul style="list-style-type: none"> • Sony BRC-300 PTZ Camera • Vaddio WallVIEW 300 PTZ (w/o wall mount) <ul style="list-style-type: none"> • Includes metal back box enclosure and face frame 	999-2225-003	\$249.00
camera not included			
	IN-Wall HD1 Recessed Camera Mounting Enclosure for the following cameras: <ul style="list-style-type: none"> • Sony EVI-HD1 PTZ Camera • Vaddio WallVIEW HD1 (w/o wall mount) <ul style="list-style-type: none"> • Includes metal back box enclosure and face frame • Reinforced camera platform for rigidity and strength 	999-2225-014	\$249.00
camera not included			
	IN-Wall for EagleEye, Precision HD & LifeSize Recessed Camera Mounting Enclosure for the following cameras: <ul style="list-style-type: none"> • Polycom EagleEye and WallVIEW PRO EagleEye • TANDBERG Precision HD & Precision HD 1080p • LifeSize Camera <ul style="list-style-type: none"> • Includes metal back box enclosure, camera platform and face frame Camera not included	999-2225-015	\$299.00





Product		Model #	List Price
 camera not included	IN-Wall H700 Recessed Camera Mounting Enclosure for the following cameras: • Sony BRC-H700 PTZ Camera • Vaddio WallVIEW PRO & CCU H700 (w/o wall mount) • Includes metal back box enclosure, camera platform and face frame • Reinforced camera platform for rigidity and strength	999-2225-016	\$349.00
 camera not included	IN-Wall Z700 Recessed Camera Mounting Enclosure for the following cameras: • Sony BRC-Z700 PTZ Camera • Vaddio WallVIEW PRO & CCU Z700 (w/o wall mount) • Includes metal back box enclosure, camera platform and face frame • Reinforced camera platform for rigidity and strength	999-2225-017	\$349.00
 camera not included	IN-Wall HD-18 Recessed Camera Mounting Enclosure for the following cameras: • Vaddio ClearVIEW HD-18 PTZ Camera • Vaddio WallVIEW & CCU HD-18 (w/o wall mount) • Includes metal back box enclosure, camera platform and face frame • Reinforced camera platform for rigidity and strength	999-2225-018	\$249.00 <i>Available Sept. 2009</i>

Add-A-Cam PRO Camera Systems

Add-A-Cam PRO Base System for Professional Camcorders





 camera not included	Add-A-Cam PRO Base System Vaddio PRO Series EZCamera Cable System for Camcorders • EZCamera PRO Camcorder Shoe • 1-RU Quick-Connect PRO Cable Break-out Interface Compatible with Sony HVR-V1U, -A1U & -Z1U; Canon XL-2, XL-H1 & XH-A1/G1 • Active Electronics Support Cat. 5 Cable Distances up to 500'	999-6500-000	\$1,795.00
----------------------------------------------------------------------------------------------------------	--------------------------------------------------------------------------------------------------------------------------------------------------------------------------------------------------------------------------------------------------------------------------------------------------------------------------------	--------------	------------





Add-A-Cam PRO - Pan/Tilt Head Option

	Pan/Tilt PRO • Broadcast Quality Pan/Tilt Head (15lbs/6.8kg rating) • More than 1 Million Steps of Resolution • Universal Camcorder Bracket for Canon and Sony Camcorders • 24VDC Power Supply Included	999-6520-000	\$4,699.00
	Wall Mount Bracket Option Wall Mount Bracket for Pan/Tilt Head • 18"(457.2mm) to Wall Mount Center •Black Power Coat Finish	998-6521-001	\$380.00
	Pedestal Mount Option Machined Pedestal Mount for Pan/Tilt Head • 8"(203.2mm) Pedestal Height •Black Power Coat Finish	998-6521-002	\$200.00
	Pipe Flange Mount Option Machined Pipe Flange Mount for Pan/Tilt Head • Fits 1.5" NPT Pipe threads •Black Power Coat Finish	998-6521-003	\$120.00
	Tripod Mount Option Tripod Mounting Adapter for Pan/Tilt Head • Fits Pro Tripods with 75mm Bowl •Black Power Coat Finish	998-6521-004	\$210.00

Accessories





EZCamera Cable Components

	Quick-Connect Box • Converts Cat. 5 back to native S-Video, composite video and power connections in a matchbox sized box that sits at the rack/head-end	998-1105-001	\$99.95
	Quick-Connect Box Rack Panel (not shown) • Rack panel to mount up to three quick-connect boxes in a rack mount application (Quick-Connect Boxes not included)	998-1105-002	\$70.00
	Quick-Connect 4 Video Power and Control Wiring Center • Supports 4 Vaddio PTZ camera systems using Cat. 5 cabling • 2-RU enclosure with centralized power supply & control ports • S-Video and composite outputs (NTSC and PAL versions)	999-5100-000	\$699.00
	EZCamera Control Adapter • RJ-45 to DB9F adapter converts Cat. 5 connector to DB9 connector	998-1001-232	\$20.00
	EZCamera Control Adapter for TANDBERG Codecs • RJ-45 to DB9M adapter for Tandberg codecs eliminates need for null-modem adapter and gender changer when converting control cabling	998-1002-232	\$20.00





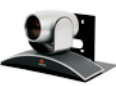



	Product	Model #	List Price
	EZCamera Control Adapter • RJ-45 to DB9F adapter converts Cat. 5 connector to DB9 connector Compatible with Polycom HDX 9000 Series Codecs	998-1003-232	\$20.00
	EZCamera Control Adapter • RJ-45 to DB9F adapter converts Cat. 5 connector to DB9 connector Compatible with Polycom HDX 8000 Series Codecs	998-1006-232	\$20.00
	18 Volt PowerRite Power Supply • Use with Model 100, Model 70, Model 50i, Model 50iR kits *See Vaddio Tech Note 113D for Cabling Distances	451-2750-018	\$65.00
	24 Volt PowerRite Power Supply** • Use with Model 100, Model 70 kits **There are restrictions for use of the 24VDC power supply -- see Tech Note 113D	451-2000-024	\$65.00
	Long Range System - Sony EVI-D70 • Quick-Connect LR Interface (composite video only) • PowerRite LR Power Supply & EZCamera Cable LR Shoe	998-9400-070	\$650.00







Camera Mounting Brackets

Camera Mounting Brackets			
	Model 50i Thin Profile Wall Mount Bracket* • Wall mount for Canon VC-C50i Camera (Black) • Mounting hardware included <i>*Camera not included</i>	535-2000-207	\$70.00
	Model 70 Thin Profile Wall Mount Bracket* • Wall mount for Sony EVI-D70 Camera (205 White, 205B Black) • Mounting hardware included <i>*Camera not included</i>	535-2000-205 535-2000-205B	\$70.00 \$70.00
	Model 100 Thin Profile Wall Mount Bracket* • Wall Mount for Sony EVI-D100 Camera (204 White, 204B Black) • Mounting hardware included <i>*Camera not included</i>	535-2000-204 535-2000-204B	\$70.00 \$70.00
	Model 300 Thin Profile Wall Mount Bracket* • Wall Mount for Sony BRC-300 Camera (Black) • Mounting hardware included <i>*Camera not included</i>	535-2000-208	\$125.00
	ClearVIEW HD-18 Wall Mount Bracket * • Wall Mount for Vaddio ClearVIEW HD-18 Camera (Black) • Heavy gauge steel construction • Mounting hardware included <i>*Camera not included</i>	535-2000-230	\$125.00
	Model HE100 Wall Mount Bracket * • Wall Mount for Panasonic AW-HE100 Camera (Black) • Heavy Duty Metal Construction • Mounting hardware included <i>*Camera not included</i>	535-2000-229	\$250.00
	Model 700 Wall Mount Bracket * • Wall Mount for Sony BRC-H700 Camera (Black) • Heavy Duty Metal Construction • Mounting hardware included <i>*Camera not included</i>	535-2000-223	\$250.00
	Model Z700 Wall Mount Bracket * • Wall Mount for Sony BRC-Z700 Camera (Black) • Heavy Duty Metal Construction • Mounting hardware included <i>*Camera not included</i>	535-2000-225	\$250.00
	Model HD1 & EagleEye 1080 HD Wall Mount Bracket* • Wall Mount for Sony EVI-HD1 & Polycom EagleEye 1080 HD (Black) • Heavy gauge steel - Mounting hardware included <i>*Camera not included</i>	535-2000-216	\$150.00
	Model Z330 Wall Mount Bracket * • Wall Mount for BRC-Z330 Camera (Black) • Heavy gauge steel construction • Mounting hardware included <i>*Camera not included</i>	535-2000-231	Call for Pricing
Wall Mounts for Polycom, TANDBERG and LifeSize Products			
	Wall Mount for Precision HD & Precision HD 1080p* • Wall Mount for TANDBERG Precision HD & Precision HD 1080p (Black) • Mounting hardware included • Heavy gauge steel construction <i>*Camera not included</i>	535-2000-217	\$150.00





	Product	Model #	List Price
	Wall Mount Shelf for TANDBERG Set-top Codecs* <ul style="list-style-type: none"> • Fits TANDBERG 990/880/770/550 MXP Set-top Codecs • Welded aluminum construction strength • Cables and connectors are concealed from view • Mounting hardware included <i>*Codec not included</i>	535-2000-250	\$299.00
	Thin Profile Wall Mount for Polycom/TANDBERG <ul style="list-style-type: none"> • Fits Polycom PowerCam or TANDBERG WAVE II Cameras • Mounting hardware included <i>*Cameras not included</i>	535-2000-219	\$70.00
	Wall Mount Shelf for Polycom VSX Codecs* <ul style="list-style-type: none"> • Wall Mount Shelf for Polycom VSX Codecs (Black) • Fits VSX-7000s, VSX-6000 and VSX-5000 Codecs • Heavy gauge steel construction • Mounting hardware included <i>*Codec not included</i>	535-2000-220	\$199.00
	Thin Profile Wall Mount for Polycom EagleEye* <ul style="list-style-type: none"> • Wall Mount for Polycom EagleEye PTZ HD Camera (Black) • Heavy gauge steel construction • Mounting hardware included <i>*Camera not included</i>	535-2000-221	\$150.00
	Thin Profile Wall Mount for LifeSize HD Camera <ul style="list-style-type: none"> • Wall Mount for LifeSize PTZ HD Camera (Black) • Mounting hardware included <i>*Camera not included</i>	535-2000-222	\$150.00





Ceiling Camera Mounting Brackets and Accessories

Camera Mounting Brackets			
	Drop Down Ceiling Mount for Small PTZ Cameras - Short Compatible with Vaddio Model 50, 70 and 100 PTZ Cameras Also compatible with Polycom PowerCam, TANDBERG Wave II & LifeSize PTZ cameras Extends approximately 1 foot below ceiling <i>Camera not included</i>	535-2000-290	\$250.00
	Drop Down Ceiling Mount for Small PTZ Cameras - Long Compatible with Vaddio Model 50, 70 and 100 PTZ Cameras Also compatible with Polycom PowerCam, TANDBERG Wave II & LifeSize PTZ cameras Extends approximately 2 feet below ceiling <i>Camera not included</i>	535-2000-291	\$295.00
	Drop Down Ceiling Mount for HD-18 PTZ Cameras Compatible with Vaddio ClearVIEW HD-18 PTZ Camera Also compatible with WallVIEW & CCU HD-18 Camera Systems Extends approximately 2 feet below ceiling	535-2000-296	\$325.00
	Drop Down Ceiling Mount for Large PTZ Cameras - Short Compatible with Vaddio PRO & CCU HD1 PTZ Camera Systems Also compatible with Polycom EagleEye & TANDBERG Precision HD Extends approximately 1 foot below ceiling <i>Camera not included</i>	535-2000-292	\$295.00
	Drop Down Ceiling Mount for Large PTZ Cameras - Long Compatible with Vaddio PRO & CCU HD1 PTZ Camera Systems Also compatible with Polycom EagleEye & TANDBERG Precision HD Extends approximately 2 feet below ceiling <i>Camera not included</i>	535-2000-293	\$325.00
	Off-Set Drop Down Ceiling Mount for Sony 3 Chip PTZ Cameras Compatible with Vaddio PRO & CCU 300, Z700 & H700 Camera Systems 1" NPT Pipe thread connects to third-party mounting hardware Extends approximately 28 inches below ceiling <i>Camera not included</i>	535-2000-294	\$399.00
	Off-Set Drop Down Ceiling Mount for Panasonic PTZ Camera Compatible with Vaddio PRO & CCU HE100 Camera Systems 1" NPT Pipe thread connects to third-party mounting hardware Extends approximately 28 inches below ceiling <i>Camera not included</i>	535-2000-295	\$399.00
	Drop Down Coupler Kit for Large/Small Platform Mounts Converts standard suspended ceiling mount to 1" NPT thread For use with 535-2000-290, -291, -292, -293 & -296 • Coupler can interface with third-party mounting hardware	535-2000-299	\$60.00
	Recessed Ceiling Conversion Kit - CeilingVIEW SD/HD Hardware Kit for Recessed Drywall or Hard Ceilings • Fits CeilingVIEW SD & HD Document Cameras 999-2008-000 & -001; 999-2009-000 & -001; 999-3008-000 & -001; 999-3009-000 & -001 (-001 - PAL cameras) • Mounting plates, trim ring and mounting hardware included	535-2000-226	\$199.00

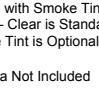

	Product	Model #	List Price
	Recessed Installation Ceiling Conversion Kit Hardware Kit for Recessed Drywall or Hard Ceilings • Fits CeilingVIEW 70 Series models: CeilingVIEW 70 PTZ – 999-2304-000 and -001 ; CeilingVIEW 70 PTZ HideAway – 999-2404-000 and -001 (001 = PAL Cameras) • Mounting plates, trim ring and mounting hardware included	535-2000-210	\$249.00
	Suspended Ceiling PTZ Camera Mount • Provides ability to mount standard Sony Model 70 or Canon Model 50iR to a tile ceiling • Includes custom cable grommet for the ceiling tile *Camera not included	535-2000-206	\$99.00
	Standard Camera Mount • Tubular design for wall mounting cameras • Max. Load - 6 lbs (2.72kg) • Swivel Angle - 360°, Tilt Angle - 90° • 1/4" - 20 Thread Mounting Screw • Length: 5.12" (130mm)	535-2000-212	\$39.00
	Universal Wall/Ceiling Mount Tubular J-shaped design for wall/ceiling mounting cameras • Cable Management Opening • Max. Load - 6 lbs (2.72kg) • Swivel Angle - 360°, Tilt Angle - 90° • 1/4" - 20 Thread Mounting Screw • Dimensions: 9.5" x 8" (242mm x 203mm)	535-2000-213	\$49.00
	Expandable Wall Mount Tubular Telescopic design for wall mounting cameras • Cable Management Opening • Max. Load - 6 lbs (2.72kg) • Swivel Angle - 360°, Tilt Angle - 90° • 1/4" - 20 Thread Mounting Screw • Length: 12" to 18.3" (305mm x 465mm)	535-2000-214	\$49.00
	Long Expandable Wall/Ceiling Mount Long Tubular Telescopic for wall and ceiling mount cameras • Cable Management Opening • Max. Load - 6 lbs (2.72kg) • Swivel Angle - 360°, Tilt Angle - 90° • 1/4" - 20 Thread Mounting Screw • Length: 24" to 40" (610mm x 1016mm)	535-2000-215	\$59.00





DomeVIEW Series

DomeVIEW Series - DomeVIEW Flush Mount			
	DomeVIEW 50iR Flush Mount Camera System Flush Mount Dome Enclosure and Canon VC-C50iR PTZ Camera with EZCamera Cable System for video, power and control over Cat. 5 • 7.3" (18.54cm) Clear Dome with White Twist & Lock Trim Ring • Plenum Rated Metal Back Box (tile support brace recommended) • Bracket included for Canon VC-C50iR • Includes Canon VC-C50iR PTZ Camera, (90° tilt, 340° total pan) • Includes EZCamera Cabling System	999-9000-050 North America ONLY	\$1,995.00
	DomeVIEW 70 Flush Mount Camera System Flush Mount Dome Enclosure and Sony EVI-D70 PTZ Camera with Long Range EZCamera Cabling System • 7.3" (18.54cm) Clear Dome with White Twist & Lock Trim Ring • Plenum Rated Metal Back Box (tile support brace recommended) • Bracket included for Sony EVI-D70 • Includes Sony EVI-D70 PTZ Camera, (90° tilt, 340° total pan) • Includes EZCamera Cabling System LR (Long Range)	999-9000-070 North America ONLY	\$1,995.00
	Tile Support Brace for Flush Mount Domes Recommended For ALL DomeVIEW Flush Mount Dome Systems and Flush Mount Domes mounted in Acoustic Ceiling Tiles • 23-3/4" (60.33cm) Tile Brace, serves as tile template	997-9000-000	\$30.00
	Flush Mount Dome and Bracket for Canon VC-C50iR • 7.3" (18.54cm) Clear Dome • White Twist & Lock Trim Ring • Plenum Rated Metal Back Box (Tile Brace recommended) • Camera Mounting Bracket for VC-C50iR	998-9000-050 NA & Int'l	\$295.00
 Shown with Smoke Tinted Dome - Clear is Standard - Smoke Tint is Optional Camera Not Included	Flush Mount Dome and Bracket for Sony EVI-D70 PTZ • 7.3" (18.54cm) Clear Dome • White Twist & Lock Trim Ring • Plenum Rated Metal Back Box (Tile Brace recommended) • Bracket included for Sony EVI-D70	998-9000-070 NA & Int'l	\$295.00





Product		Model #	List Price
DomeVIEW Series - DomeVIEW Indoor Pendant Mount			
	DomeVIEW 50iR Indoor Pendant Camera System Indoor Pendant Mount Dome Enclosure and Canon VC-C50iR PTZ Camera with EZCamera Cabling System <ul style="list-style-type: none"> • 7.3" (18.54cm) Clear Dome with White Twist & Lock Trim Ring • White, High Impact Plastic Pendant Enclosure with 1.5" NPT Fitting • Bracket included for Canon VC-C50iR • Includes Canon VC-C50iR PTZ Camera, (90° tilt, 340° total pan) • Includes EZCamera Cabling System 	999-9100-050 North America ONLY	\$2,095.00
	DomeVIEW 70 Indoor Pendant Camera System Indoor Pendant Mount Dome Enclosure and Sony EVI-D70 PTZ Camera with EZCamera Cabling System <ul style="list-style-type: none"> • 7.3" (18.54cm) Clear Dome with White Twist & Lock Trim Ring • White, High Impact Plastic Pendant Enclosure with 1.5" NPT Fitting • Bracket included for Sony EVI-D70 • Includes Sony EVI-D70 PTZ Camera, (90° tilt, 340° total pan) • Includes EZCamera Cabling System LR (Long Range) 	999-9100-070 North America ONLY	\$2,095.00
	Indoor Pendant Dome and Bracket for Canon VC-C50iR <ul style="list-style-type: none"> • 7.3" (18.54cm) Clear Dome with White Plastic Pendant • 1.5" NPT Fitting and Twist & Lock Trim Ring • Bracket included for Canon VC-C50iR 	998-9100-050 NA & Int'l	\$395.00
	Indoor Pendant Dome and Bracket for Sony EVI-D70 <ul style="list-style-type: none"> • 7.3" (18.54cm) Clear Dome with White Plastic Pendant • 1.5" NPT Fitting and Twist & Lock Trim Ring • Bracket included for Sony EVI-D70 	998-9100-070 NA & Int'l	\$395.00
Shown with Smoke Tinted Dome - Clear is Standard - Smoke Tint is Optional Camera Not Included			
Dome Options for DomeVIEW Flush Mount and Indoor Pendant Mount Domes			
	Smoke Tinted Dome Option <ul style="list-style-type: none"> • 7.3" (18.54cm) Smoke Tinted Dome add-on kit for Flush Mount or Indoor Pendant Dome 	997-9000-073	\$50.00
	Clear Replacement Dome Option <ul style="list-style-type: none"> • 7.3" (18.54cm) Clear Dome Replacement for Flush Mount or Indoor Pendant Dome 	997-9000-074	\$50.00

DomeVIEW Series

DomeVIEW Series - DomeVIEW Outdoor*, Environmental Pendant Mount Dome			
	DomeVIEW 50iR Outdoor* Pendant Dome System Outdoor Pendant Mount Dome Enclosure and Canon VC-C50iR PTZ Camera with EZCamera Cabling System <ul style="list-style-type: none"> • 8.2" (20.8cm) Smoke Tinted Dome • Dual Shell Construction with Integrated 1.5" NPT Pendant Mount • Heater and Blower Kit with 24VAC Power Supply • Bracket included for Canon VC-C50iR • Includes Canon VC-C50iR PTZ Camera, (90° tilt, 340° total pan) • Includes EZCamera Cabling System 	999-9200-050 North America ONLY	\$2,295.00
	DomeVIEW 70 Outdoor* Pendant Dome System Outdoor Pendant Mount Dome Enclosure and Sony EVI-D70 PTZ Camera with EZCamera Cabling System <ul style="list-style-type: none"> • 8.2" (20.8cm) Smoke Tinted Dome • Dual Shell Construction with Integrated 1.5" NPT Pendant Mount • Heater and Blower Kit with 24VAC Power Supply • Bracket included for Sony EVI-D70 • Includes Sony EVI-D70 PTZ Camera, (90° tilt, 340° total pan) • Includes EZCamera Cabling System LR (Long Range) 	999-9200-070 North America ONLY	\$2,295.00
<i>*DomeVIEW Outdoor Pendant Dome Systems are available for sale in North America Only.</i>			
	Outdoor Pendant Dome with Bracket for Canon VC-C50iR <ul style="list-style-type: none"> • 8.2" (20.8cm) Smoke Tinted Dome • Dual Shell with Integrated 1.5" NPT Pendant Mount • Integrated 1.5" NPT Pendant Mount • Heater and Blower Kit with 24VAC Power Supply • Bracket included for VC-C50iR PTZ Camera 	998-9200-050 North America ONLY	\$625.00
	Outdoor Pendant Dome with Bracket for Sony EVI-D70 <ul style="list-style-type: none"> • 8.2" (20.8cm) Smoke Tinted Dome • Dual Shell with Integrated 1.5" NPT Pendant Mount • Integrated 1.5" NPT Pendant Mount • Heater and Blower Kit with 24VAC Power Supply • Bracket included for Sony EVI-D70 PTZ Camera 	998-9200-070 North America ONLY	\$625.00
Shown with Smoke Tinted Dome STD Clear is Optional			
*Outdoor Domes are available for sale in North America Only			
Camera Not Included			

	Product	Model #	List Price
Dome Options for DomeVIEW Outdoor Domes			
	Clear Dome Option - Outdoor Domes 8.2" (20.8cm) Clear Dome add-on kit for Outdoor Pendant Dome with Stainless Screws	997-9200-082	\$90.00
	Smoke Tinted Replacement Dome - Outdoor Domes 8.2" (20.8cm) Smoke Tinted Replacement Dome with Stainless Steel Screws	997-9200-083	\$90.00
Accessories for DomeVIEW Indoor and Outdoor Pendant Mount Domes			
	Wall Mounting Kit for Indoor and Outdoor Pendant Dome Enclosures • Heavy Duty Aluminum Cast Construction • 1.5" NPT threads easily onto domes • 85 Mph (136.8kph) wind rating • Easy to install	998-9300-000	\$125.00
	Wall Mount with Pole Mount Kit Indoor and Outdoor Pendant Dome Enclosures • Includes Wall Mount and Pole Mount Kits • Accommodates 3" (7.62cm) to 10" (25.4cm) poles • Easy to install	998-9300-001	\$175.00
	Ceiling Mount Kit for Indoor and Outdoor Pendant Dome Enclosures • Mounting Box with Heavy Duty 1.5" NPT Adapter • Requires 1.5" NPT Pipe between Mount and Dome • Easy to install	998-9300-002	\$100.00

Accessories

Cables, Microphone and Wide Angle Lens			
	Custom Cables ControlVIEW/Control Expander Link Cable	999-1005-008	\$150.00
	ControlVIEW/MicVIEW Link Cable	999-1005-009	\$150.00
	PTZ Camera Control Cable – Mini-DIN8 to DB9	999-1005-010	\$15.00
	Video Cables 12' (3.66M) S-Video Cable	430-0001-015	\$30.00
	25' (7.76M) S-Video Cable	430-0001-025	\$40.00
	50' (15.24M) S-Video Cable	430-0001-050	\$70.00
	12' (3.66M) Composite Video Cable	430-0002-015	\$20.00
	Category 5 Cables (plenum rated) 50' (15.24M) Cat. 5 Cable	420-0011-050	\$60.00
	75' (22.86M) Cat. 5 Cable	420-0011-075	\$80.00
	100' (30.48M) Cat. 5 Cable	420-0011-100	\$110.00
	Wide Angle Camera Lens Options Canon VC-C50i .75X Wide Angle Lens	534-0000-002	\$160.00
	Wide Angle Lens for Sony EVI-D70 .5X Wide Angle Lens	534-0000-001	\$120.00



9433 Science Center Drive
Minneapolis, MN 55428

Toll Free: 800-572-2011
vaddio.com

©2009 Vaddio - All rights reserved. Reproduction in whole or in part without written permission is prohibited. Specifications and pricing are subject to change without notice. ClearVIEW, ProductionVIEW, PreVIEW, WallVIEW, Add-A-Cam, DomeVIEW, CoverVIEW, MicVIEW, AutoVIEW, CeilingVIEW, ControlVIEW, TouchVIEW, StepVIEW, TrackVIEW, EZCamera, Quick-Connect, EZCable, PTZCAM, IN-Wall, HSDS and PowerRite are trademarks of Vaddio. All other trademarks are property of their respective owners. Form 07/01/2009 Rev. A